

Camp d'Aprenentatge de la ciutat de Tarragona  
Tarraco arriba a l'escola

# TARRACO ARRIBA A L'ESCOLA

## Solucionari

Camp d'Aprenentatge de la ciutat Tarragona  
Generalitat de Catalunya  
Departament d'Educació

**Autors:** Núria Montardit Bofarull  
Marta Segura Pont  
Jordi Tortosa Giménez  
M. Joana Virgili Gasol

## Camp d'Aprenentatge de la ciutat de Tarragona Tarraco arriba a l'escola

1. Observa la imatge de la maqueta que ens reconstrueix com devia ser Tàrraco al segle II dC.

- Marca a la imatge el perímetre de la muralla.
- Uneix cada requadre amb la part de la ciutat que li correspon.
- Després separa amb una ratlla cada sector :

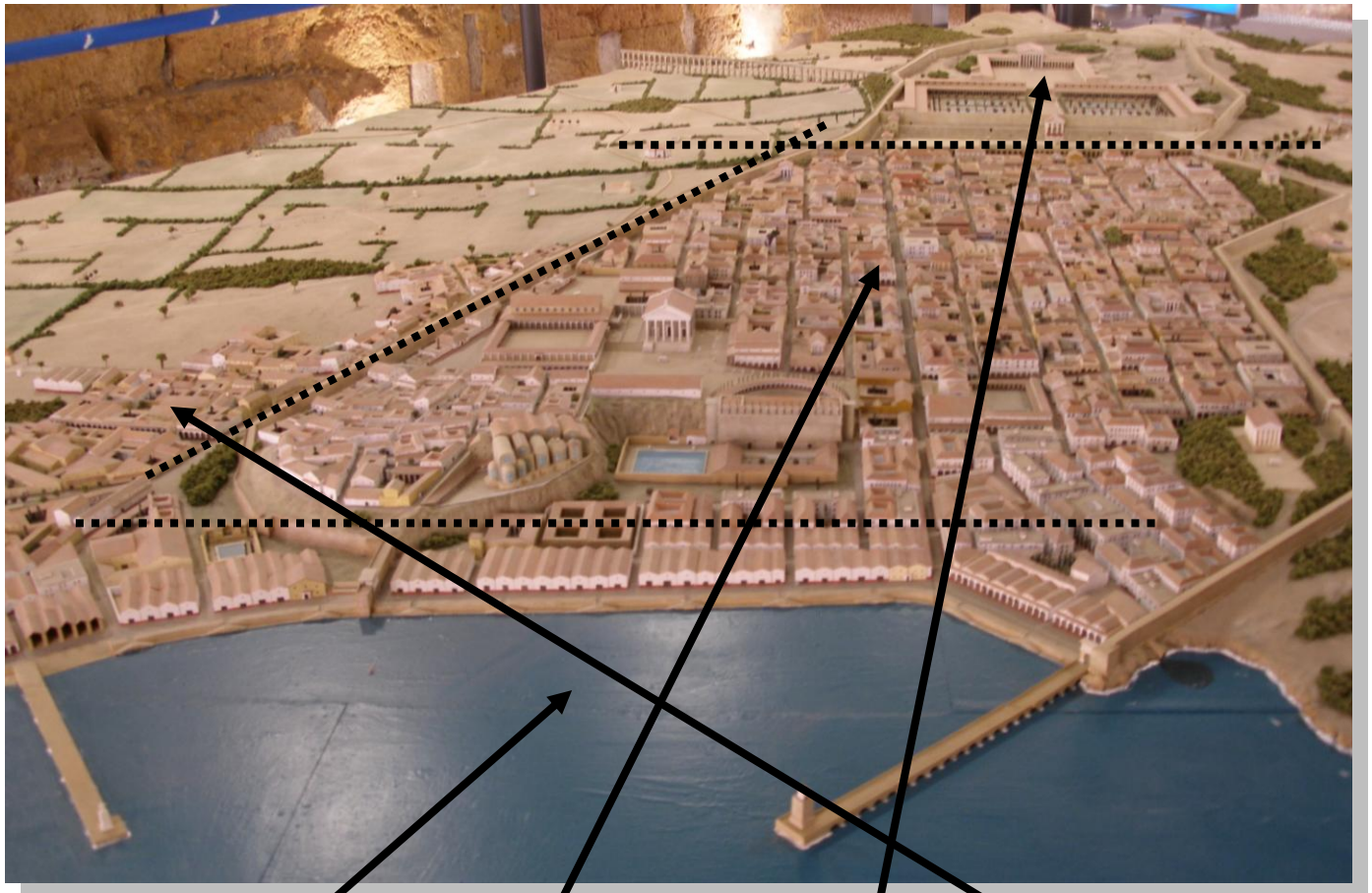

1. Zona portuària

2. Zona residencial  
(d'habitatges)

3. Part alta

4. Zones  
suburbanes (fora de  
muralles)

# Camp d'Aprenentatge de la ciutat de Tarragona

## Tarraco arriba a l'escola

2. Situa cada edifici a la part de Tarraco que li correspongui: 1. Zona portuària, 2. Zona residencial, 3. Part alta i 4. Zones suburbanes:

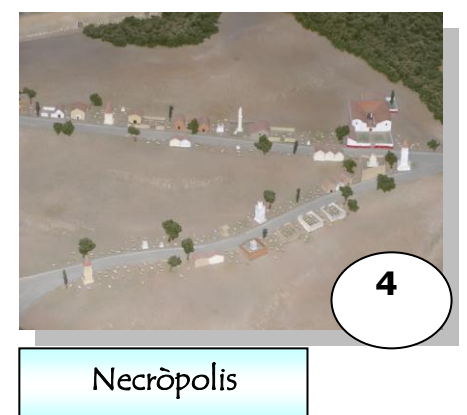
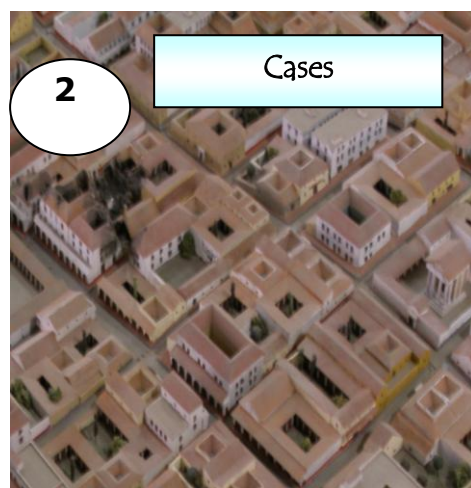
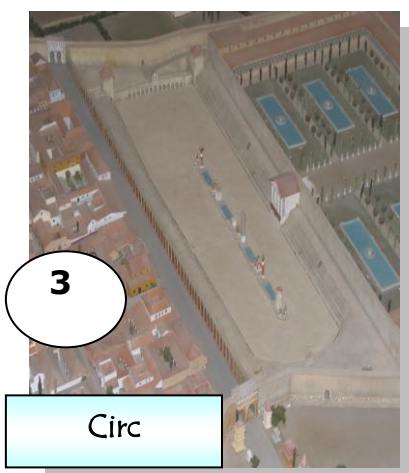
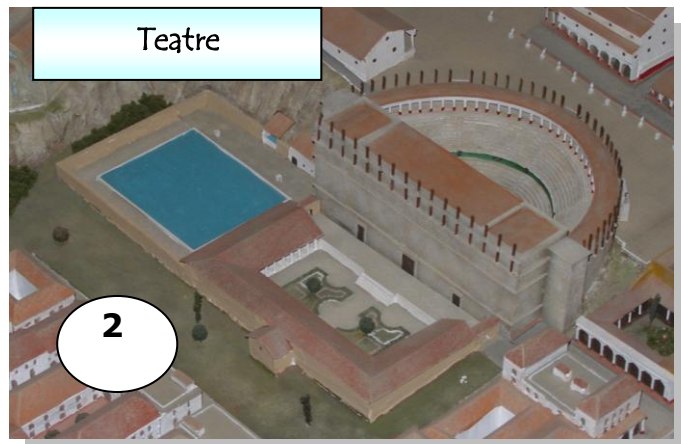

Camp d'Aprenentatge de la ciutat de Tarragona  
Tarraco arriba a l'escola

3. Situa cada escena en la part de Tarraco que li correspongui: 1. Zona portuària, 2. Zona residencial, 3. Part alta i 4. Zones suburbanes:



2

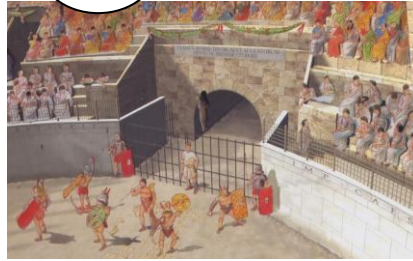

4

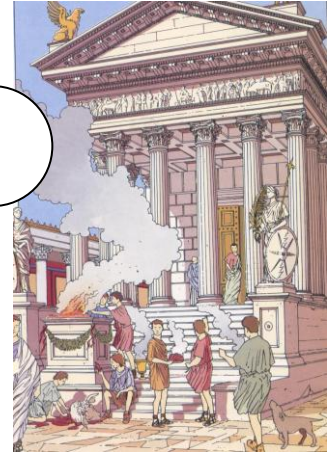

2  
3

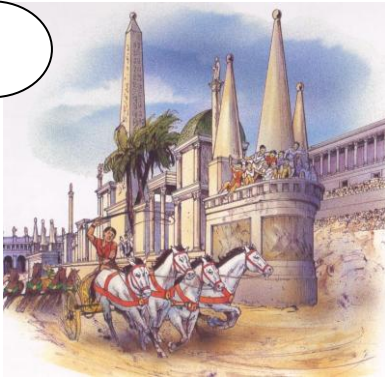

3



4

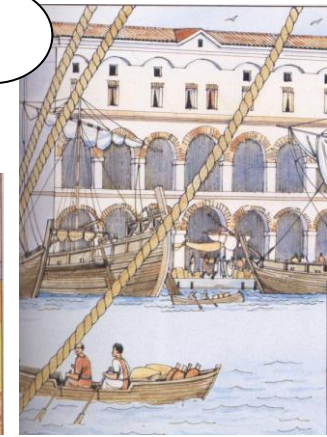

1

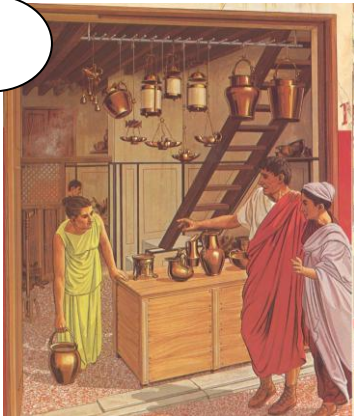

2

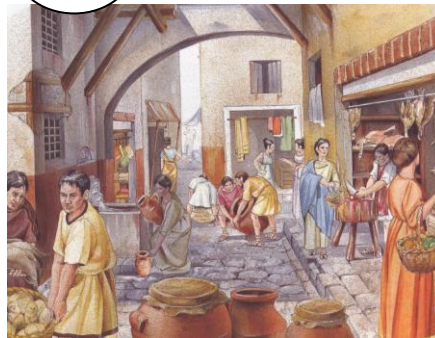

2



2



2

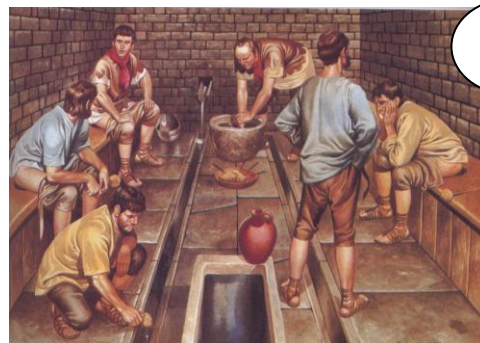

2

Camp d'Aprenentatge de la ciutat de Tarragona  
Tarraco arriba a l'escola

4. Identifica aquests objectes i després pensa en quina zona de la ciutat s'usarien més habitualment: : 1. part alta, 2. Zona residencial, 3. zona portuària i 4. fora muralles.



Carro

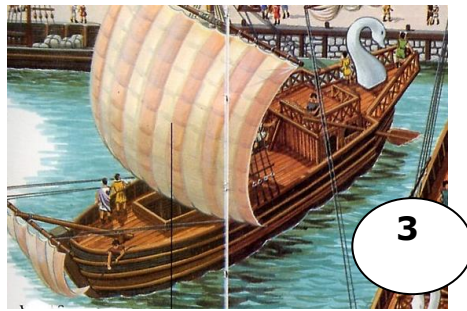

Vaixell



Altar

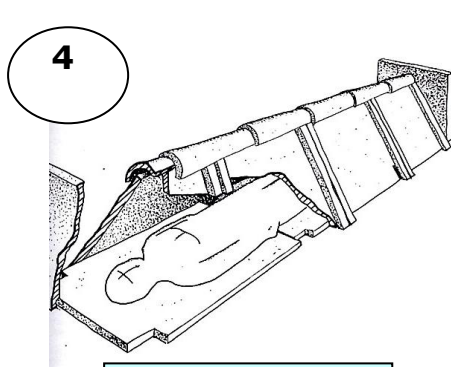

Tomba

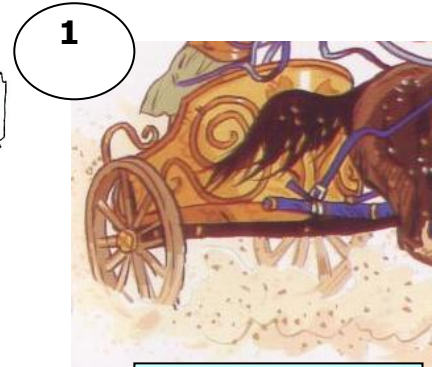

Carro

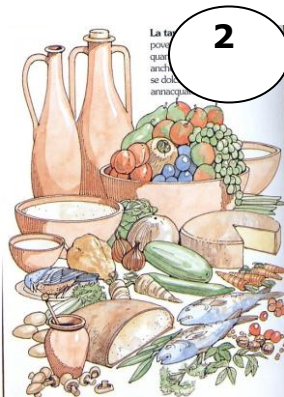

Menjar

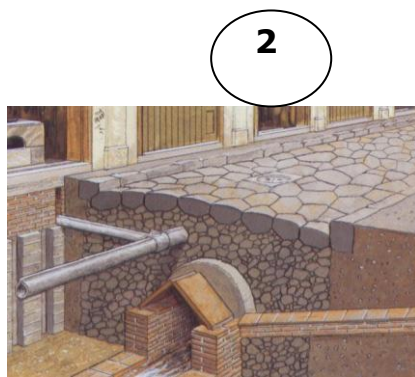

Clavegueram



Espasa

Camp d'Aprenentatge de la ciutat de Tarragona  
Tarraco arriba a l'escola

5. Situa cada personatges a l'edifici que li pugui correspondre:  
circ, amfiteatre, carrer, fòrum, temple, *domus* (casa unifamiliar rica), *insula* (casa de pisos de pobres), via, teatre, taverna, termes, font, barberia, forn



Amfiteatre

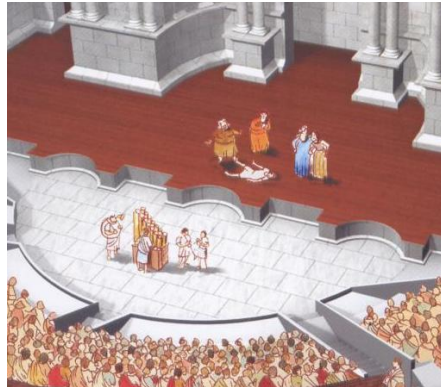

teatre



circ



Termes

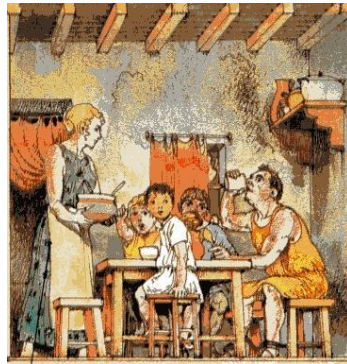

ínsula

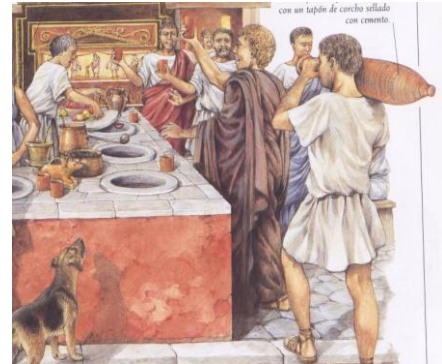

popina (taverna)



Barberia



via



font



Domus (triclinium)

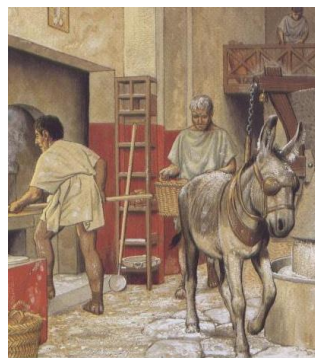

forn



fòrum, temple

Camp d'Aprenentatge de la ciutat de Tarragona  
Tarraco arriba a l'escola